

Article number: 07110400001

Description: Universal joint single 0.110.400.001  
S=92 X= Bore with keyway

## Measures

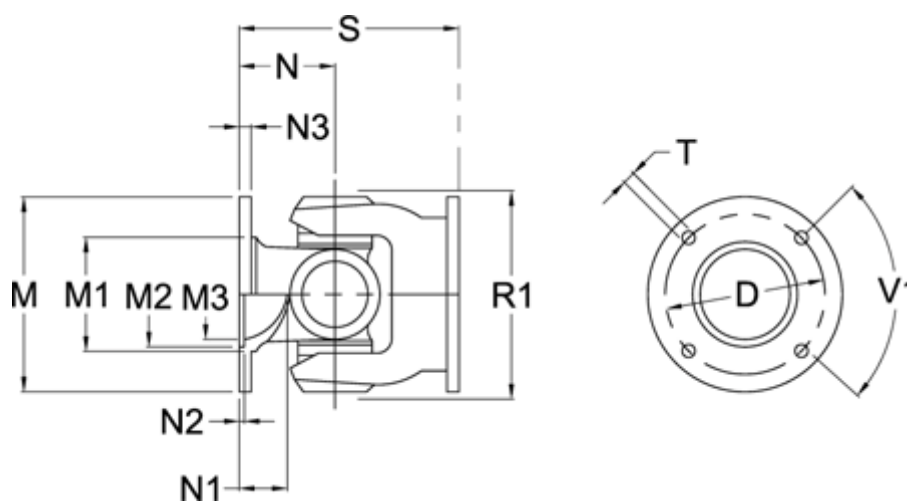

D	= 84 $\pm$ 0,1	N2	= 2,5 $\pm$ 0,5
Flange diameter M	= 100	N3	= 7
M1	= 86	Number og Flangeholes	= 6
M2	= 57	R1	= 98
M3	= 52	S min	= 92
Max. Bending Angle degrees	= 20	T	= 8 B12
N	= 46	V1 degrees	= 60
N1	= 20		